

Morpho-like optical phenomenon in the neotropical lycaenid butterfly *Mercedes atnius* (HERRICH-SCHÄFFER, 1853)

(Lepidoptera: Lycaenidae)

by

ZSOLT BÁLINT, SERGE BERTHIER, JULIE BOULENGUEZ & VICTORIA WELCH

received 23.I.2009

Abstract: We report a study of two distantly related day-flying lepidopterous insects [Lepidoptera, Lycaenidae: *Mercedes atnius* (HERRICH-SCHÄFFER, 1853); Nymphalidae: *Morpho rhetenor* (CRAMER, 1775)]. Their wing dorsa generate superficially similar blue structural colour. Cover- and ground-scale layers in the wings of the species involved were investigated using optical and electronic microscopy to detect micro- and nanostructures. The layers of the scales in the two species are qualitatively different in terms of their morphologies and pigmentation. Wing reflectivity was measured using spectroscopic and goniometric techniques and simple models were proposed to analyse the measurements taken. Optical properties of the two butterflies are not as significantly different as their morphologies. We hypothesize that the different wing-beats of the species examined have an important role and explain how the two optically similar phenomena can work differently in nature.

Introduction: The fascinating Neotropical butterfly genus *Morpho* FABRICIUS, 1807 (Insecta: Lepidoptera: Nymphalidae: Morphinae) has received particular attention from entomologists, who very recently studied their diversity and phylogeny using new methods (PENZ & DEVRIES, 2002). Moreover the physicists working on these organisms tend to focus their investigations in the genus on detecting micro- and nanostructures in the wing scales and on the mechanism by which these structures manipulate light. Quite a number of papers have been published in the last decades on this topic in scientific journals in the physics literature (BERTHIER et al. 2006; VUKUSIC et al. 1999; VUKUSIC & SAMBLES, 2000). One of the most studied species is *Morpho rhetenor* (CRAMER, 1775), probably because it has a relatively simple scale morphology compared with congeners (see below).

We are aware that certain Neotropical butterflies also possess *Morpho*-like vivid blue on their wing surface. Some of these are the representatives of the genus *Mercedes* JOHNSON, 1993 (type species: *Papilio calus* CRAMER, 1775), which belongs to a large and diverse clade of eumaeine lycaenids (Lycaenidae: Theclinae: Eumaeini), considered by certain workers to be a single genus *Calycopys* SCUDDER, 1872 (LAMAS, 2004; ROBBINS & DUARTE, 2005). All of the five-six *Mercedes* species, which possess ventrally a cryptic pattern and colouration common amongst tropical lycaenids, share the character having *Morpho*-like blue colouration on their hind-wing surface. This colouration also extends to the anal and medial parts of the fore wing. However, one species in the genus, *M. atnius* (HERRICH-SCHÄFFER, 1853), has a completely black fore-wing dorsum. This species is one member of the most common and widespread "Calycopis" taxon, which is represented by large series of individuals in entomological collections. *Mercedes atnius* (H.-S.) is widely distributed in pristine forests of the Guyana and in the lower Amazon basin in South America.

Different butterfly species vary in their wing-beat frequencies; this frequency variation is not always due to aerodynamic/ energetic considerations - in *Heliconius* species (butterflies that are coloured by pig-

ments), species-specific characteristic wing-beat frequencies have evolved which are aerodynamically costly but which have a role in signalling (SRYGLEY, 2004). Essentially, in these species, the pattern of pigment on the wing can be considered a coloured display, which is alternately visible and not, as the wings open and close, with the temporal pattern of display visibility depending on the wing-flap frequency: a phenomenon which has been investigated in the context of locomotor mimicry (SRYGLEY, 1999).

Species with structural colouration present a more complex situation than those with pigments because the appearance of colour-producing structures is highly dependent upon the angle from which they are viewed: thus any coloured display on the wings of these species will not only become visible or not as the wings open and close, but will also vary in hue as the wing angle changes. Surprisingly, the possibility of signalling relating to wing-flapping has not been investigated in structurally coloured species (BERTHIER, 2005).

Mercedes atnius (H.-S.) and *Morpho rhetenor* (CR.) live in the same habitat. When observed with the naked eye, museum specimens seem to exhibit an identical blue colouration (col. pl. 6: 1), which „flashes“ as the specimen is tilted. These „flashes“ are due to the very directional reflection. It is known that, when flying, a butterfly with photonic-crystal-like structures in the wing scales can produce a flicker contrast (VUKUSIC et al., 2001). In this paper we discuss these flashes; in particular, we consider that their frequency could be a way for them to recognize conspecific individuals. We are aware that this phenomenon will require more detailed discussion in the future, especially in the context of data collected in the field, as and when this is collected. In this paper, then, we studied museum specimens, with our primary goal being to understand the emitted signals better: studies which constitute a necessary prelude to subsequent investigations of the flicker contrast phenomenon and to studies of these „flashes“ in vivo /their behavioural significance. We do not speculate how the receptors (eyes) take the optical phenomena we describe and analyse.

Materials and methods: Specimens: Scientifically curated and set *Mercedes atnius* (H.-S.) specimens originating from French Guyana were provided by the Museum National d'Histoire Naturelle (Paris, France), whilst *Morpho rhetenor* (CR.) specimens were received from dealers' stocks reared in captivity.

Observation: The optical properties of the blue dorsal side of *Mercedes atnius* (H.-S.) and *Morpho rhetenor* (CR.) were measured and compared. First, geometric data were obtained from optical and electron microscopic observations. Then, optical properties were analysed: reflectance spectra were measured; then the directional repartition of reflected light was measured. Eventually, the use of these optical properties to produce flashes of lightning signals is discussed.

Morphology of the scales: Initial observations of the wings of both species with a classical light microscope revealed the arrangement, colour, size and shape of the different scales, which were present in two layers: cover-scales and ground-scales. The light microscope used was an Olympus BX51, attached to a digital camera. Scanning Electron Microscopy (SEM) provides information on the disposition, size and shape of the fine nanostructures in the scales (ridges, lamellae and interspacing). Samples were examined under a Zeiss 440 Stereoscan SEM.

Results

Scale morphology: *Morpho rhetenor* (CR.) cover scales are atrophied and can be observed only at higher magnification (col. pl. 6: 2)). Thus, in a study dedicated to optical properties they can be neglected. That is probably the

main reason why this species has been so much examined (VUKUSIC et al., 1999; GRALAK et al., 2001; KINOSHITA et al., 2002; PLATTNER, 2004). Ground scales are typically $75\mu\text{m} \times 150\mu\text{m}$ in size; they are pigmented.

In fig. 3a, a cross-section of a *Mercedes atnius* (H.-S.) cover scale is visible: there is a multilayer (reflector) in the body of the scale. The height of longitudinal ridges is approximately $0.1\mu\text{m}$. The microcells comprised by the ridges and the cross ribs are more or less regularly arranged, but even in this sole image, conspicuous irregularities can be observed, especially if the uppermost layer filling completely the microcells is also taken into consideration. At the bottom of this image, the upper surface of a ground scale is visible; it possesses a network of open microcells, comprising of longitudinal ridges and cross ribs. Generally speaking, lycaenid butterflies are known to present so-called 'pepper-pot' structures (BIRÓ et al., 2003), which can display a wide array of structural variety. People familiar with butterfly scale microstructures would probably identify the *Mercedes atnius* (H.-S.) cover scale structure with *Urania*-type type IIa according to VUKUSIC et al. (2005). This kind of narrow, tightly layered scale structure has been documented several times in Lycaenidae (ELIOT, 1973; TILLEY & ELIOT, 2002).

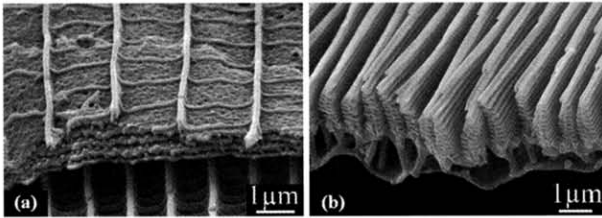

Figure 3: (a) *Mercedes atnius* (HERRICH-SCHÄFFER, 1853) cover scale and (b) *Morpho rhetenor* (CRA-MER, 1775) ground scale; SEM images.

Looking at the dorsal side of *Mercedes*'s hind-wing (col. pl. 6: 2), one can see that the rows of the cover scales completely hide the ground scales, which can be seen only when the cover scales are removed. They display the natural brown colour of melanin. The cover scales do not possess any pigments, but are completely transparent.

A section of *Morpho rhetenor* (CR.) hind wing was examined. In fig. 3b, the ground scale cross-section allows the structure to be seen: the upper lamina (the dorsal side of the scale) presents the classical *Morpho* type of pine-tree-shaped ridge structure. Measurements taken from such images give dimensions that can be used in simulations of the photonic structures. The height of the longitudinal ridges is more than $1\mu\text{m}$, and the ridges are laterally fluted by several parallel-running nanoridges.

Hence, the scale morphologies of the two species investigated are completely different. *Mercedes atnius* (H.-S.) possesses two layers of scales, the transparent and multilayered cover scales, which are supported by the heavily pigmented ground scales and show an ordinary microcell-structure typical for lepidopteran scales. By contrast, the cover scale of *Morpho rhetenor* (CR.) is atrophied and cannot play any role in the optical phenomena produced by the wing surface. The *Morpho rhetenor* (CR.) ground scale is heavily pigmented but displays a structure which is distinctive both in qualitative and quantitative terms. Curiously, the optical properties of the two species do not differ so drastically, as we demonstrate below.

Optical properties: For optical measurements a sample of a whole *Mercedes atnius* (H.-S.) hind wing

was mounted on a black paper. A square piece similar in size was cut from the the most homogeneous area of the *Morpho rhetenor* (Cr.) hind wing and mounted on a similar substrate. The bodies of the scales have slight variations on the wing membrane (col. pl. 6: 2), consequently the orientations of the structures playing roles in optical phenomena are not rigorously uniform over the illuminated area.

Hemispherical spectroscopy: The reflectivity of the wings was measured on a Cary 5 spectrometer equipped with an integrating sphere, in the range 200-700nm, under unpolarized light. A classical mounting was used, whereby the plane sample was placed on the sphere's aperture (fig. 4a). A diffraction grating was rotated in such a way that only the measurement wavelength, λ , illuminated the sample. The illuminated area was 12mm x 4mm in size. The light reflected by the sample in every direction was integrated by the sphere because its inner surface is coated with a white diffusing material. The resulting light in the sphere is measured at one point of the inner surface. Measurements were normalized with a lambertian diffuse reflectance standard (Spectralon). The originality of our mounting is that we used a set of substrates that allowed us to mount the sample in the sphere in such a way that the angle of incidence on the sample, i , can have non-zero values (Figure 4b): an arrangement which is not possible with a classical mounting. The apex-base axis of the sample is in the plane of incidence.

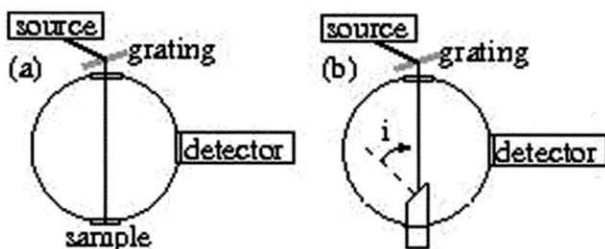

Figure 4: (a) classical mounting and (b) use of substrates with calibrated angles for hemispherical spectroscopy measurement.

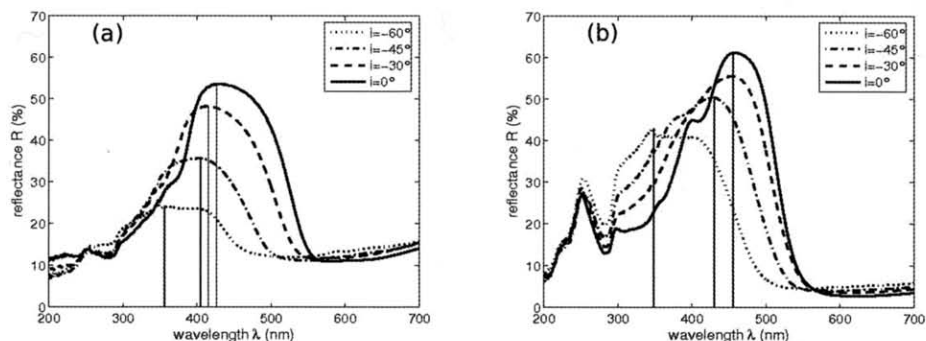

Figure 5: Hemispherical reflectance spectra of (a) *Mercedes atnius* (HERRICH-SCHÄFFER, 1853) and (b) *Morpho rhetenor* (CRAMER, 1775) wings at various angles of incidence. Bars indicate the position of the maximum value of reflectance.

Both species' hemispherical spectra (fig. 5) present a reflectance maximum greater than 50% due to the multilayer reflectors in their scales.

It is noteworthy that *Morpho rhetenor* (CR.) presents a reflectance peak in the UV domain that *Mercedes atnius* (H.-S.) does not possess. This absence of UV peaks seems to be a characteristic property of reflectance produced by lycaenids (BÁLINT, in prep.).

On both hemispherical measurements, the position of the reflectance maximum, λ_{max} , shifts when the incidence on the wing, i , changes, which can be interpreted with thin film interference theory (MERRITT, 1925).

For modelling purposes, we simplified the origin of the structural colour into optical interferences in a single layer equivalent to the wing, whose thickness and refractive index were e and n , lying on a substrate of refractive index n_s . When an incident beam meets the air/layer interface, it is partly refracted, with angle of refraction, r , in the layer and partly reflected. The refracted beam can then be reflected on the layer/substrate interface and refracted through the layer/air interface. The path difference, δ , between these two reflected beams is the classical thin film interference path difference: $\delta = 2ne \cos(r)$. We can assume that $n_s > n$. Thus, both beams get a phase shift of π during their reflection, and the phase difference $\Delta\varphi$ between them is given by:

$$\Delta\varphi = \frac{2\pi}{\lambda} \delta = \frac{2\pi}{\lambda} 2ne \cos(r)$$

When the reflectance is at one of its maxima, there exists an integer k such that . Therefore, using SNELL's law:

$$\sin(i)^2 = n^2 - \frac{k^2}{4e^2} \lambda_{max}^2$$

Actually, to get a linear behaviour of $\sin(i)^2$ as a function of λ_{max}^2 , we have to take into account the tilt angle $\theta_{s/w}$ of the reflecting structures on the wing (fig. 6): the incidence on the reflecting structures is $i = i + \theta_{s/w}$. The most linear behaviour of $\sin(i)^2$ as a function of λ_{max}^2 is obtained for $\theta_{s/w} = 5^\circ$ in *Mercedes atnius* (H.-S.) and for $\theta_{s/w} = 5^\circ$ in *Morpho rhetenor* (CR.). In both cases this behaviour is very linear, since the correlation coefficient is more than 90%; thus a single layer is enough to build a first model for the reflecting structures. The value of the tilt angle $\theta_{s/w}$, taken by spectroscopy, was not accessible from microscopy. This value could be useful for building computer simulations of the diffraction by the wings.

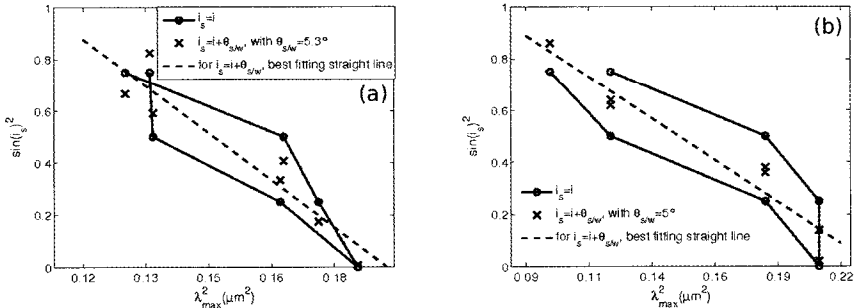

Figure 6: Sine square of the incidence angle versus the square of the wavelength of the reflection maximum for (a) *Mercedes atnius* (HERRICH-SCHÄFFER, 1853) and (b) *Morpho rhetenor* (CRAMER, 1775).

Hemispherical spectroscopy gives spectral information on all the reflected light, without taking into account the direction in which the light is reflected. To get spatial information, gonio-spectroscopy was used.

Gonio-spectroscopy: The Bidirectional Reflectance Distribution Function (BRDF) was determined experimentally in the laboratory with a gonio-spectrophotometer. It shows in which directions light leaves the studied surface- something which it is impossible to predict, except for very simple surfaces. The BRDF therefore gives information on the angle from which the bright colouration of the butterfly will be visible. The experimental parameters are presented in fig. 7. A halogen light source was used for measurement in visible range. The illuminating light was guided from the source by an optical fibre, in the (x, z) plane. The illumination beam diameter was 3 mm. The longitude of illumination was $\varphi_i=180^\circ$. The angle of incidence θ_i could be chosen between 0° and 90° , but it did not change during a measurement. The sample was placed in the horizontal (x, y) plane. In our case, we tried to place the reflecting structures in the horizontal plane by maximizing the signal detected in the specular direction ($\theta=\theta_i, \varphi=0$). The apex-base axis of the wing was placed on the x-axis. The detected beam was guided by a fibre into a spectrometer. The detection direction (θ, φ) could be varied. For a given wavelength λ , a set of measurements on a wing allowed us to draw a spatial diffraction map. Since the ridging is parallel to the apex-base axis, what was measured can be thought in terms of conical diffraction. This configuration was chosen because it allowed data to be collected that could not have been measured in a classical diffraction mounting because, in the latter, the illumination and the detection optics cannot overlay.

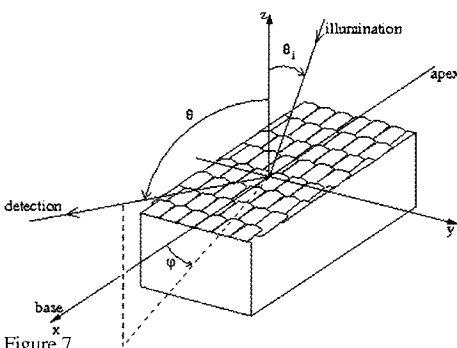

Figure 7

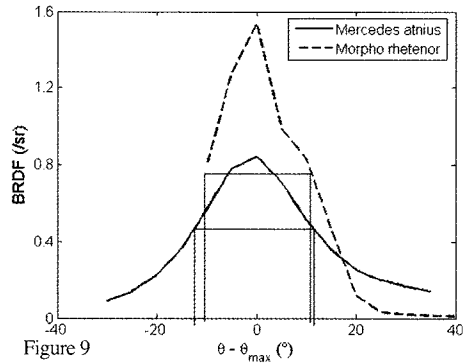

Figure 9

Fig. 7: Experimental geometrical conditions for BRDF measurement.

Fig. 9: Dispersion of the reflected light in the θ -plane for *Mercedes atnius* (HERRICH-SCHÄFFER, 1853) and *Morpho rhetenor* (CRAMER, 1775). These are the shapes of diffraction maps of fig. 8 in their BRDF maximum φ_{max} -plane. The angular widths (FWHM) are almost the same for both species but the intensities are different.

BRDF was performed for $\lambda=450$ nm, corresponding to the reflectivity maximum for both species, with $\theta_i = 30^\circ$ for *Mercedes atnius* (H.-S.), and $\theta_i = 20^\circ$ for *Morpho rhetenor* (CR.). Of all the diffraction maps of *Morpho* species, which have been plotted so far, *Morpho rhetenor* (CR.)'s one is the most similar in general shape to that of *Mercedes* (col. pl. 6: 8), which was a factor in our choice of this species for comparison. Most of the reflected blue light is reflected in the φ -plane, over an angle greater than 90° for both species. Such an extension is perhaps due to the tilting of the layer surfaces (VUKUSIC et al., 1999) but it could also

be due to the diffraction by the ridges of the scales (BERTHIER et al., 2006). In the θ -plane, by contrast, the reflection angle is weak-approximately 20° for both species (fig. 9). The maximum was not detected in the specular direction. Actually, the mean plane of the reflecting structures can not easily be placed in the horizontal (x, y) plane and the apex-base axis of the wing can not easily be placed in the incidence (x, z) plane.

Discussion: It has been hypothesized that gleaming structural colour of the wing dorsa is used as an important tool for signalling in butterflies (VANE-WRIGHT, 1984). However, how these signals work in a natural environment, has never been tested.

The factors causing the optical differences between the appearances of these animals in their natural environment and specimens preserved in museums fall into two main categories- the first category comprises those factors relating to the environmental light conditions, whilst the second concerns factors relating to the animal's movement in vivo. With regard to the former category, in a tropical forest habitat, light conditions vary fundamentally, from open biotopes (over river surfaces, forest edges and high canopies) to partly closed (forest trails and openings) and entirely closed (under the canopy or mid story) biotopes, such that natural testing is particularly important.

The reflectance maxima measured here are relevant to the light conditions because they give an indication of the reflectors' efficiencies. Both species present a reflectance maximum greater than 50%, which is rather high for structurally coloured butterflies (BERTHIER, 2006). Highly efficient reflectors are particularly important for butterflies living in the lower and darker places of the forest. In this case, both species, occupy fairly bright light environments, so would not be expected to possess very highly efficient reflectors.

The second category of natural factors affecting the butterfly's appearance in vivo (those due to the insect's movement) can be further subdivided into the effects due to wing-beat frequency with which we have concerned ourselves here and to a second subdivision of effects due to wing-beat „shape“ or „asymmetry“, neither of which has been previously considered or tested in structurally coloured species.

All the *Morpho* butterflies, including *Morpho rhetenor* (Cr.), have a gliding type of flight, which means a relatively low rate of wing beats ($\sim 1/s$) (“gliding flight”, SCOTT, 1990) and a nearly horizontal position of the wings between successive beats compared with lycaenids. This correlates with their small bodies and large wing surfaces. In contrast, all the thecline lycaenids (Lycaenidae: Theclinae), including *Mercedes atnius* (H.-S.), display rapid or furious type of flight, which means they have a much higher rate of wing beats (5/s or more) (“clapping flight”, SCOTT, 1990). This correlates with their relatively robust bodies and a less extensive wing surfaces. This is a simplified view, but gives a valuable insight, allowing us to estimate the visual signal emitted in a given direction by the two species during flight.

If we assume a constant shape of the wings during flight, a mean angular amplitude for both species of about 120° and a constant angular speed during one beat, the signal received by an observer situated above the flying butterflies is schematically represented in fig. 10. The blue signal is associated with a very directional reflection, seen in a given direction with a frequency equal to that of the wing beat, i.e. $\sim 1\text{Hz}$ for *Morpho rhetenor* (Cr.) but 5 Hz for *Mercedes atnius* (H.-S.). In the latter case, the flashes are slightly overlapping and the signal in a given direction, nearly always visible. Therefore, we hypothesize that the similar optical properties produced by museum specimens studied in laboratory conditions actually work rather differently when they are examined in natural conditions on living animals.

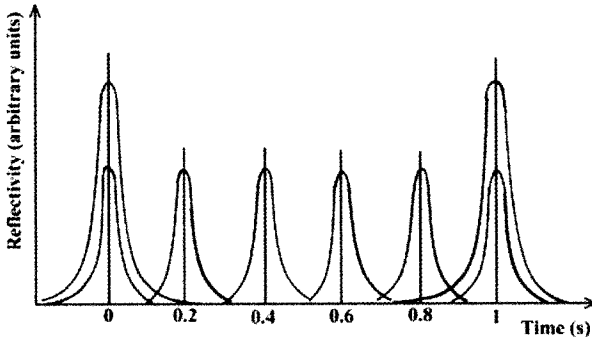

Figure 10: Theoretical signal observed during the flight above the butterfly. This diagram was built copying and translating dispersion graphs of Figure 9.

Morpho rhetenor (Cr.) ♂♂ glide in the tropical forest canopy, over trails or rivers, which is more or less uniform habitat with regard to light conditions. If it is not puddling, the individual has a constant patrolling flight, sometimes taking considerable distances (A. NELD, pers. comm.). The expanded wing surfaces generate a stable reflectivity which is changed by the animal itself only by random but furious wing flapping. We term this kind of signal the low wing-beat signal (LWBS). *Mercedes atnius* (H.-S.) ♂♂ each establish a territory on leaves of branches growing over a trail or river surface or other sunny places, for example, at forest edges. The dorsal blue is advertised only when the individual is in flight, which is generally short and takes place through a more complex area with regard to light conditions. The increased speediness caused by rapid wing beat signal (RWBS), most probably works differently from LWBS. This RWBS/ LWBS dichotomy provides a mechanism by which these taxa can be distinguished, with the possibility that taxa with LWBS pay attention to individuals with RWBS, and vice versa. This is supported by the data that *Mercedes atnius* (H.-S.) and *Morpho rhetenor* (Cr.) display more or less the same geographical overlapping distribution: both of them Pan-American. They are certainly not competitors and have differing behaviour.

It is also noteworthy that the appearance of signals from some pigmented species is known to be further complicated by effects due to wing-beat asymmetry (SRYGLEY & ELLINGTON, 1999). Naturally, we are aware that, should such flight asymmetry be found in these or other structurally coloured butterflies, this would impact upon the appearance of the signal- all the more so (cf. pigmented butterflies) because of the angular variation in hue typical of structural colours.

Conclusion: The scale morphology and the optical properties of two neotropical butterflies species belonging to distantly related families, *Mercedes atnius* (H.-S.) and *Morpho rhetenor* (Cr.) (Nymphalidae), were studied. The wing dorsa of both of the species examined display an iridescent type of structural blue with a similar hue. It was found that while the iridescent ground scales of *Morpho* are pigmented, the iridescent scales of *Mercedes*, by contrast, are the cover scales and they are transparent. The structures of these scales are qualitatively distinct, representing two main types: *Mercedes* = *Urania* type; *Morpho* = *Morpho* type. The optical properties of the species investigated do not reveal any qualitative difference. Hemispherical spectroscopic and gonio-spectroscopic figures are almost identical, both from a spatial and spectral point of view. The only difference is displayed by their rela-

tive intensities and the two species cannot be distinguished solely on these properties, as the intensity depends on the relative distance between the emitter and the receptor.

We hypothesize that the frequency of the wing-beats has an influence on how the superficially similar optical properties appear in nature, as the two species display different styles of flight, supporting different kinds of signalling systems: a low wing beat signal (LWBS) = *Morpho rhetenor* (Cr.), and a rapid wing beat signal (RWBS) = *Mercedes atnius* (H.-S.). The importance of wing-beats in signal emission is supported by the field observations that sympatric *Mercedes* species possess different flight-styles with different numbers of wing-beats.

Acknowledgements: We thank Dr. JACQUES PIERRE (Museum National d'Histoire Naturelle, F-Paris) for providing specimens and support with our collection studies. Thanks to S. BORENSZTAJN for the SEM images. The work in Hungary was funded by OTKA T042972 to ZSOLT BÁLINT. The work was also supported by EU6 NEST/PATHFINDER/BioPhot 12915.

References

- BERTHIER, S. (2005): Approche éthologique des couleurs. Exemple des insectes: 11-14. In HARDY, J., (ed.), Iris, essence et sens des couleurs. - Nancy.
- BERTHIER, S., CHARRON, E. & J. BOULENGUEZ (2006): Structure and optical properties of the wings of Morphidae. - *Insect Science* **13**: 145-157, Beijing.
- BERTHIER, S., CHARRON, E. & A. DA SILVA (2003) Determination of the cuticle index of the scales of the iridescent butterfly *Morpho menelaus*. - *Optics communications* **228**: 349-356, North-Holland.
- BIRÓ, L. P., BÁLINT, Zs., KERTÉSZ, K., VÉRTESY, Z., MÁRK, G. I., HORVÁTH, Z. E., BALÁZS, J., MÉHN, D., KIRICSI, I., LOUSSE, I. V. & J. P. VIGNERON (2003): Role of photonic-crystal-type structures in the thermal regulation of a Lycaenid butterfly sister species pair. - *Physical Review E* **67**: 021907, 1-7, Ridge NY.
- GRALAK, B., TAYEB, G. & S. ENOCH (2001): *Morpho* butterflies wings color modeled with lamellar grating theory. - *Optics Express* **9-11**: 567-578.
- ELIOT, J. N. (1973): The higher classification of the Lycaenidae (Lepidoptera): a tentative arrangement. - *Bull. Brit. Mus. N. H. (Entomology)* **28**: 371-505, London.
- KINOSHITA, S., YOSHIOKA, S., FUJII, Y. & N. OKAMOTO (2002): Photophysics of structural color in the *Morpho* butterflies. - *Forma* **17**: 103-121, Fukuoka.
- LAMAS, G. (2004): In HEPPNER, J. (ed.), Atlas of Neotropical Lepidoptera. Checklist Part 4 A. Hesperioidea - Papilionoidea: xxxiv, 1-439. - Scientific Publishers, Gainesville.
- MERRITT, E. (1925): A spectrophotometric study of certain cases of structural color. - *Journal of the Optical Society of America and Review of Scientific Instruments* **11**(2): 93-98, Washington DC.
- PENZ, C. & Ph. DEVRIES (2002): Phylogenetic Analysis of *Morpho* Butterflies (Nymphalidae, Morphinae): Implications for Classification and Natural History. - *Amer. Mus. Novit.* **3374**: 1-33, New York.
- PLATTNER, L. (2004): Optical properties of the scales of *Morpho rhetenor* butterflies: theoretical and experimental investigation of the back-scattering of light in the visible spectrum. - *J. Roy. Soc. Interface* **1**: 49-59.
- ROBBINS, R. K. & M. DUARTE (2005): Two phylogenetically significant new *Calycopis* species (Lycaenidae: Theclinae: Eumaeini). - *J. Res. Lepid.* **38**: 27-34, Beverly Hills.
- SCOTT, J. A. (1990): Adult structure and function: 108-151. In KUDRNA, O. (ed.), *Butterflies of Europe*.

Introduction to Lepidopterology 2: 1-557. - Aula Verlag, Wiesbaden.

- SRYGLEY, R. B. (1999): Locomotor mimicry in *Heliconius* butterflies: contrast analyses of flight morphology and kinematics. - Philosophical Transactions of the Royal Society, London, B. 354: 203-214.
- SRYGLEY R. B. (2004): The Aerodynamic costs of warning signals in palatable mimetic butterflies and their distasteful models. - Proceedings B of the Royal Society, London, B. 271: 589-594,
- SRYGLEY, R. B. & C. P. ELLINGTON, (1999): Discrimination of flying mimetic passion-vine butterflies (*Heliconius*). - Proc. Roy. Soc. London (B) **266**: 2137-2140, London.
- TILLEY, R. J. D. & J. N. ELIOT (2002): Scale microstructure and its phylogenetic implications in lycaenid butterflies (Lepidoptera, Lycaenidae). - Trans. Lep. Soc. Japan **53**: 153-180, Tokyo.
- VANE-WRIGHT, R. I. (1984): The Role of Pseudosexual Selection in the Evolution of Butterfly Colour Pattern: 251-253. In VANE-WRIGHT, R. I. & PH. R. ACKERY (eds): The Biology of Butterflies: 1-429. - Academic Press, London.
- VUKUSIC, P., SAMBLES, J. R., LAWRENCE, C. R. & R. J. WOOTTON (1999): Quantified interferences and diffraction in single Morpho butterfly scales. - Proc. Roy. Soc. (B) **266**: 1403-1411, London.
- VUKUSIC, P. & J. R. SAMBLES (2000): Colour effects in bright butterflies. - Journal of the Society of Dyers and Colourists **116**: 376, Bradford.
- VUKUSIC, P., SAMBLES, J. R., LAWRENCE, C. R. & R. J. WOOTTON (2001): Now you see it - now you don't. - Nature **410**: 36, London.
- VUKUSIC, P., SAMBLES, J. R. & H. GHIRADELLA (2005): Optical classification of microstructure in butterfly wing-scales. - Photonics Science News **6**: 61-66.

Addresses of the authors

ZSOLT BÁLINT

Hungarian Natural History Museum
H-1088, Budapest, Baross utca 13, Hungary.
balint@nhmus.hu, corresponding author

SERGE BERTHIER & JULIE BOULENGUEZ

Institut des Nanosciences de Paris, UMR CNRS
Université Pierre et Marie Curie-Paris 6, case 80, 140 rue de Lourmel
F-75015 Paris, France

VICTORIA WELCH: Laboratoire de Physique du solide

Facultés Universitaires Notre Dame de la Paix, 61 rue de Bruxelles
B-5000 Namur

Colour plate 6/ Farbtafel 6

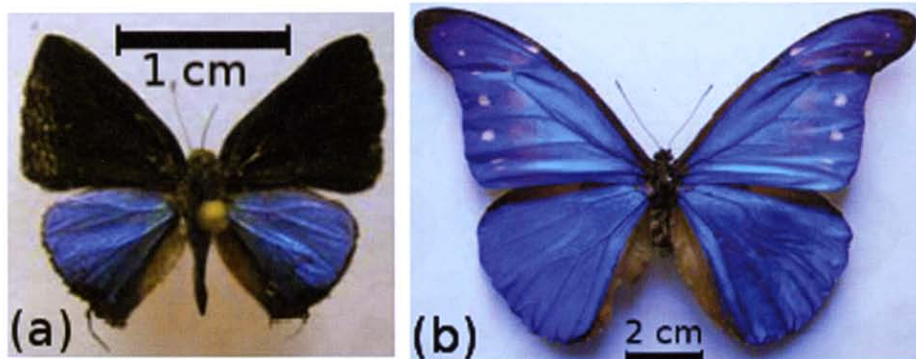

Figure 1: Dorsal surface of (a) *Mercedes atnius* (HERRICH-SCHÄFFER, 1853) and (b) *Morpho rhetenor* (CRAMER, 1775)(HNHM specimens).

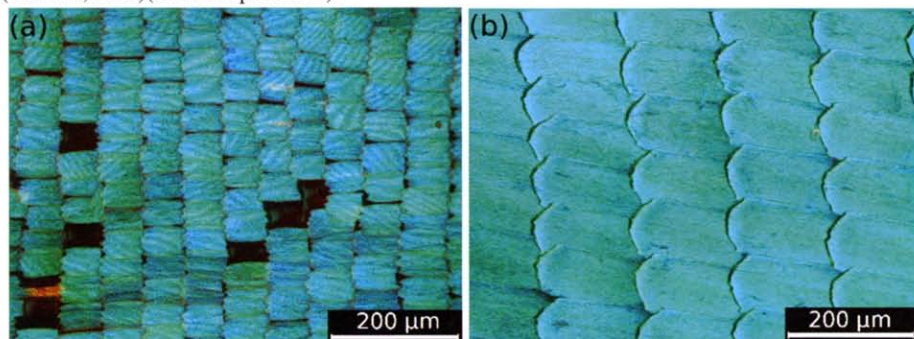

Figure 2: (a) *Mercedes atnius* (HERRICH-SCHÄFFER, 1853) and (b) *Morpho rhetenor* (CRAMER, 1775) scales in hind-wing dorsum under normal incidence; showing transparent *M. atnius* (H.-S.) cover scales and atrophied *M. rhetenor* (Cr.) cover scale.

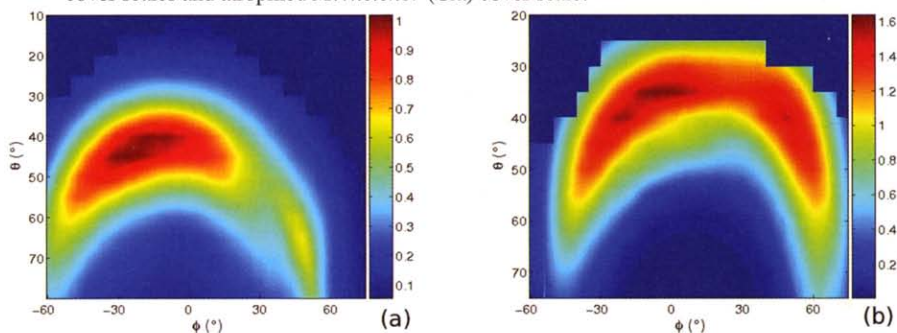

Figure 8: Experimental diffraction maps (BRDF values in s_r^{-1} are in colour scale) for $\lambda = 450$ nm and (a) $\theta_i = 30^\circ$ for *Mercedes atnius* (HERRICH-SCHÄFFER, 1853) and (b) $\theta_i = 20^\circ$ for *Morpho rhetenor* (CRAMER, 1775).